

- SET PROVIDED WITH MAIN BODY AND SIX INSERTS, EXTRACTION TOOL, AND PLASTIC CASE

- 1
- 2
- 3
- 4
- 5

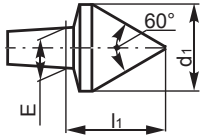

8841



| Code No.  | W* | d <sub>1</sub> | E    | l <sub>1</sub> |
|-----------|----|----------------|------|----------------|
| 7-571-202 | 2  | 0.71           | 0.28 | 0.83           |
| 7-571-203 | 3  | 0.98           | 0.47 | 1.10           |
| 7-571-204 | 4  | 1.10           | 0.59 | 1.20           |
| 7-571-205 | 5  | 1.57           | 0.87 | 1.67           |
| 7-571-206 | 6  | 2.36           | 1.10 | 2.42           |

\*Size



8842

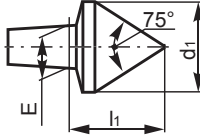

| Code No.  | W* | d <sub>1</sub> | E    | l <sub>1</sub> |
|-----------|----|----------------|------|----------------|
| 7-571-302 | 2  | 0.71           | 0.28 | 0.69           |
| 7-571-303 | 3  | 0.98           | 0.47 | 0.91           |
| 7-571-304 | 4  | 1.10           | 0.59 | 0.98           |
| 7-571-305 | 5  | 1.57           | 0.87 | 1.34           |
| 7-571-306 | 6  | 2.36           | 1.10 | 1.99           |

\*Size



8843

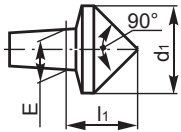

| Code No.  | W* | d <sub>1</sub> | E    | l <sub>1</sub> |
|-----------|----|----------------|------|----------------|
| 7-571-402 | 2  | 0.71           | 0.28 | 0.59           |
| 7-571-403 | 3  | 0.98           | 0.47 | 0.75           |
| 7-571-404 | 4  | 1.10           | 0.59 | 0.83           |
| 7-571-405 | 5  | 1.57           | 0.87 | 1.10           |
| 7-571-406 | 6  | 2.36           | 1.10 | 1.57           |

\*Size



8847

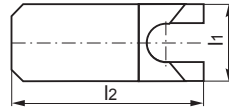

| Code No.  | W* | l <sub>1</sub> | l <sub>2</sub> |
|-----------|----|----------------|----------------|
| 7-571-902 | 2  | 0.79           | 1.97           |
| 7-571-903 | 3  | 1.18           | 2.76           |
| 7-571-904 | 4  | 1.77           | 3.94           |
| 7-571-905 | 5  | 2.17           | 4.72           |
| 7-571-906 | 6  | 2.56           | 6.30           |

\*Size



8844

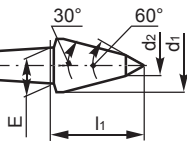

| Code No.  | W* | d <sub>1</sub> | d <sub>2</sub> | E    | l <sub>1</sub> |
|-----------|----|----------------|----------------|------|----------------|
| 7-571-502 | 2  | 0.59           | 0.24           | 0.28 | 1.06           |
| 7-571-503 | 3  | 0.71           | 0.31           | 0.47 | 1.22           |
| 7-571-504 | 4  | 0.98           | 0.47           | 0.59 | 1.59           |
| 7-571-505 | 5  | 1.10           | 0.51           | 0.87 | 1.79           |
| 7-571-506 | 6  | 1.57           | 0.71           | 1.10 | 2.50           |

\*Size



8845

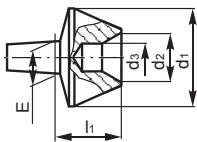

| Code No.  | W* | d <sub>1</sub> | d <sub>2</sub> | d <sub>3</sub> | E    | l <sub>1</sub> |
|-----------|----|----------------|----------------|----------------|------|----------------|
| 7-571-602 | 2  | 1.10           | 0.47           | 0.24           | 0.28 | 0.73           |
| 7-571-603 | 3  | 1.57           | 0.75           | 0.39           | 0.47 | 0.94           |
| 7-571-604 | 4  | 2.17           | 0.87           | 0.39           | 0.59 | 1.44           |
| 7-571-605 | 5  | 2.76           | 1.26           | 0.39           | 0.87 | 1.65           |
| 7-571-606 | 6  | 3.94           | 1.97           | 0.59           | 1.10 | 2.20           |

\*Size



8846

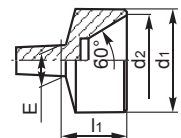

| Code No.  | W* | d <sub>1</sub> | d <sub>2</sub> | E    | l <sub>1</sub> |
|-----------|----|----------------|----------------|------|----------------|
| 7-571-702 | 2  | 1.10           | 0.94           | 0.28 | 0.85           |
| 7-571-703 | 3  | 1.57           | 1.38           | 0.47 | 1.04           |
| 7-571-704 | 4  | 2.17           | 1.89           | 0.59 | 1.54           |
| 7-571-705 | 5  | 2.76           | 2.48           | 0.87 | 1.85           |
| 7-571-706 | 6  | 3.94           | 3.54           | 1.10 | 2.44           |

\*Size



8831-KPL

- Revolving centers with interchangeable inserts
- Set provided with main body and seven different inserts in plastic case

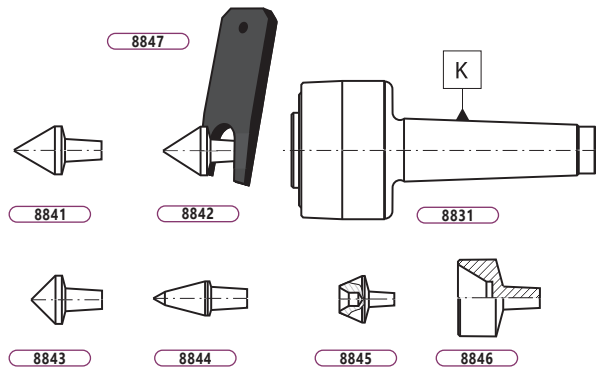

| K MT | Max. weight [lbs] | RPM   | Max. concentr. error [in] | Code No.  | Max. concentr. error [in] | Code No.   |
|------|-------------------|-------|---------------------------|-----------|---------------------------|------------|
|      |                   |       |                           | Precision | Standard                  |            |
| 2    | 154               | 5,000 | 0.0004                    | 7-571-002 | 0.0008                    | 7-571-0020 |
| 3    | 264               | 4,000 | 0.0004                    | 7-571-003 | 0.0008                    | 7-571-0030 |
| 4    | 616               | 3,000 | 0.0004                    | 7-571-004 | 0.0008                    | 7-571-0040 |
| 5    | 1,430             | 2,500 | 0.0006                    | 7-571-005 | 0.0012                    | 7-571-0050 |
| 6    | 2,640             | 2,000 | 0.0006                    | 7-571-006 | 0.0012                    | 7-571-0060 |